

SMART SOLAR SHELTER

MDT-tex[®]
Membranes & Structures

MDT-TEX SHORT FACTS

INTRODUCTION

As consequences of environmental issues, that the world will face in the next decades, the society and the future generations have to deal with disruptive changes within the reach of mobility and the way we design our urban environment. The electrification of the mobility sector goes hand in hand with the challenge of decentralizing our energy grid and creating a reliable, secure and sustainable source of energy supply.

MDT-tex has decided to incorporate this challenge into its company philosophy on future product developments. With respect to the scope of opportunities MDT-tex has in the field of membrane construction the decision was made to redesign the multi award winning tulip shape into an energy harvesting canopy which adds greater value to urban and public spaces. The Smart Solar Shelter is a modular and broad adaptable solution, which does not only serve as decentralized energy harvesting product, but further integrates itself organically into various surroundings and serves as an icon for our environmental mission.





SMART SOLAR SHELTER ASYMMETRICAL

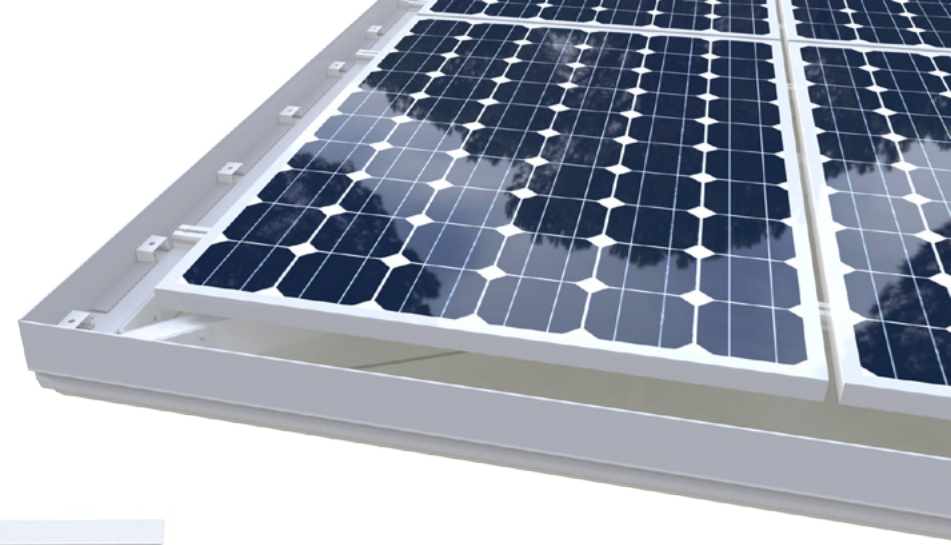

DEVELOPMENT

The innovative construction with a asymmetrical mast, serves as a generous shade provider, withstanding high wind loads due to its robust construction and forms a durable membrane.

At the same time, solar panels ensure maximum decentralized energy generation. The green energy can be used for direct charging by consumers or stored in a battery for later use.

DIMENSIONS ARE IN MILLIMETERS
*all measurements are rounded



MEMBRANE : PVC 650 g/sq.m

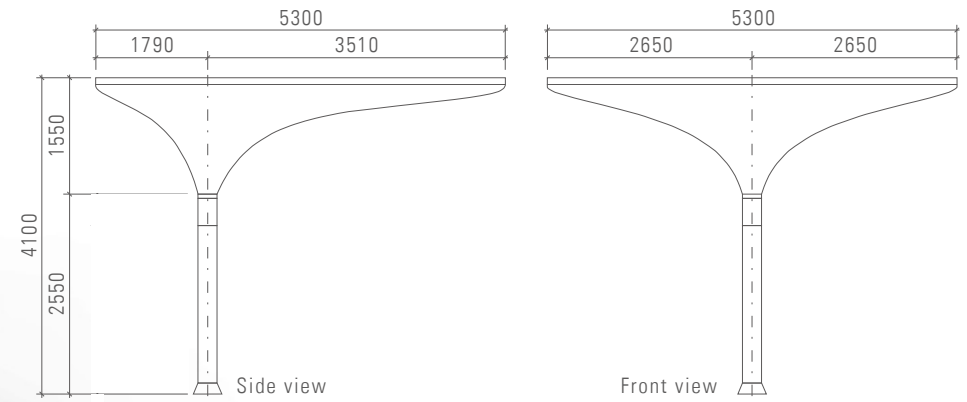

SMART SOLAR SHELTER

ASYMMETRICAL

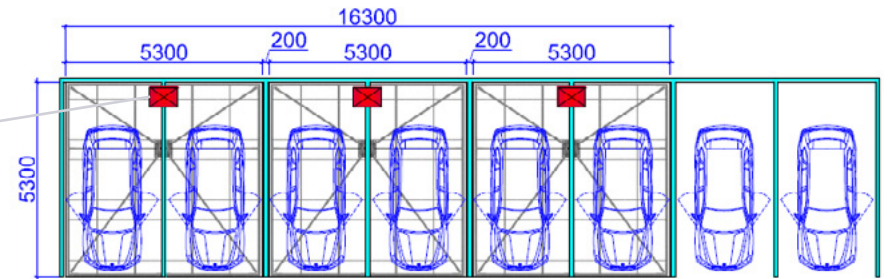
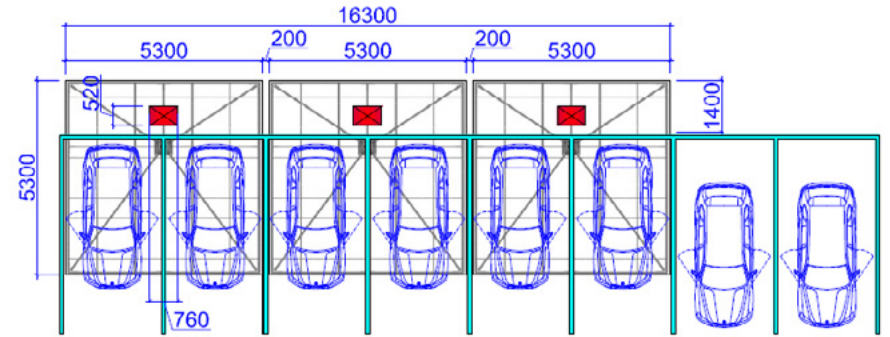
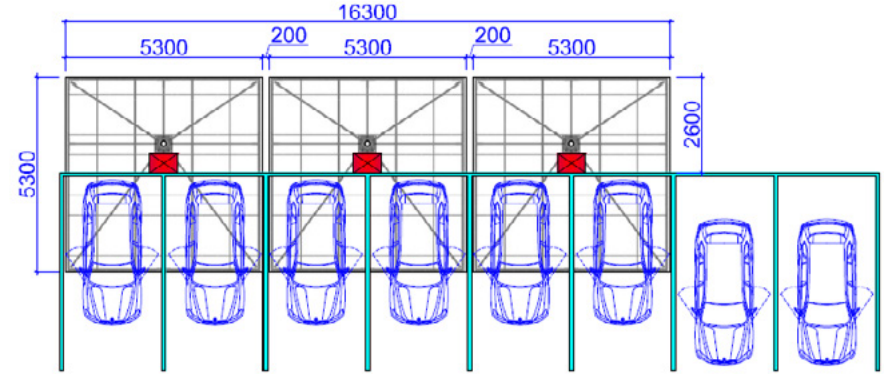
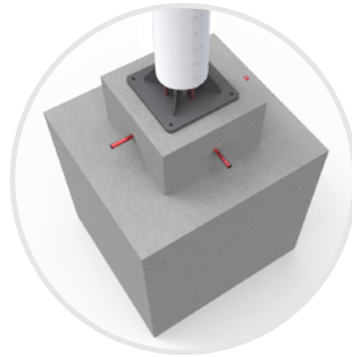
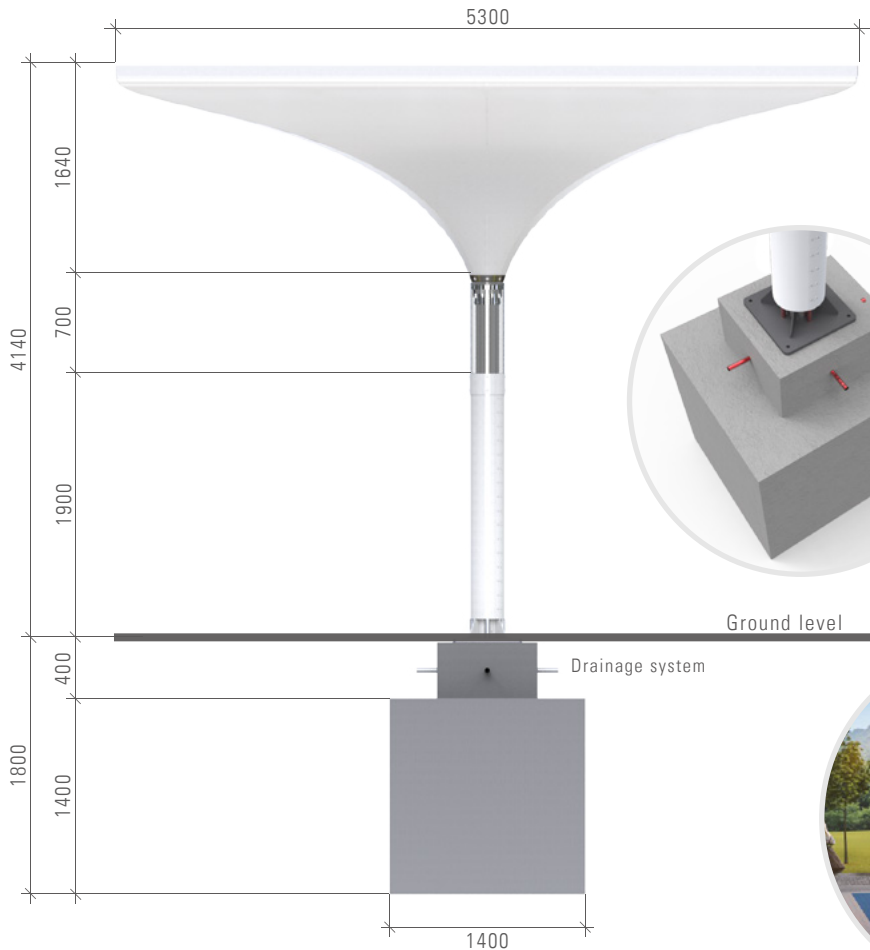

STRUCTURE Fixed, steel construction with central mast and photovoltaic modules above the membrane

Terra HP high power charging
760 X 525 MM, H-1900 MM

DIMENSIONS ARE IN MILLIMETERS
*all measurements are rounded

SMART SOLAR SHELTER SYMMETRICAL

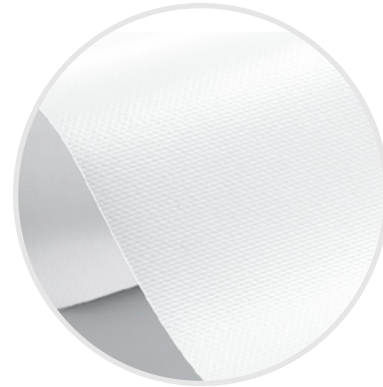
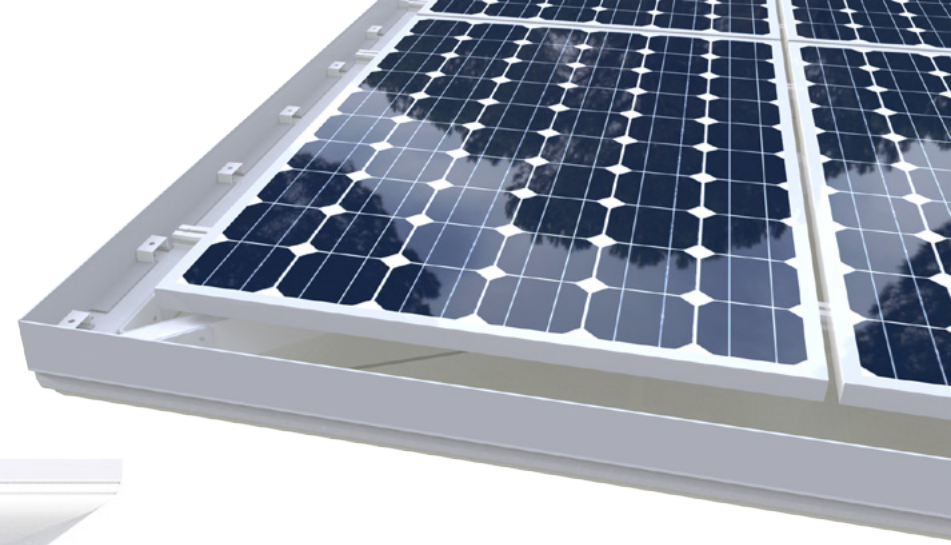

MEMBRANE : PVC 650 g/sq.m

DEVELOPMENT

In a new development the tulip-shaped shade structures are transformed into solar carports capable of harvesting solar-energy and rainwater.

The 5.3 x 5.3m square structure having a central mast can serve as shelter for two cars. Given its modular design, several structures can be placed next to each other in a linear or group configuration.

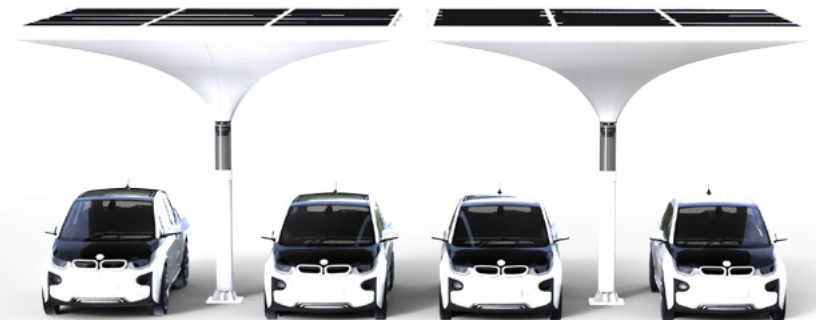

SMART SOLAR SHELTER

SYMMETRICAL

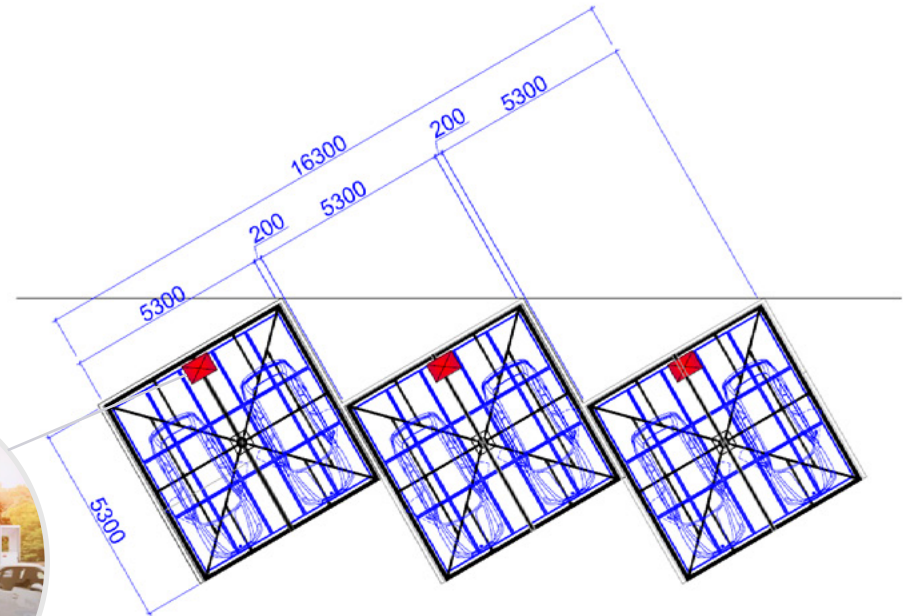
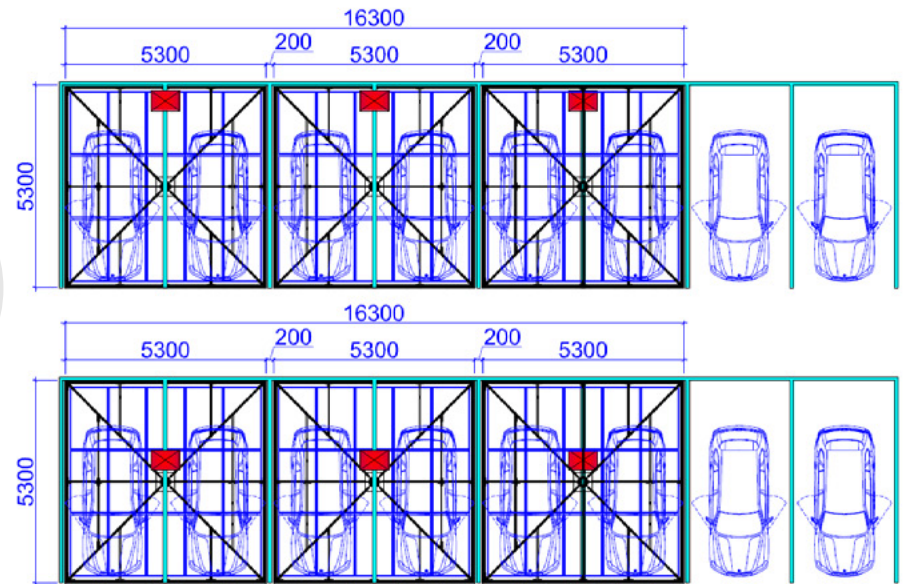
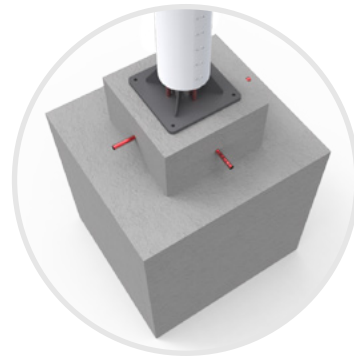
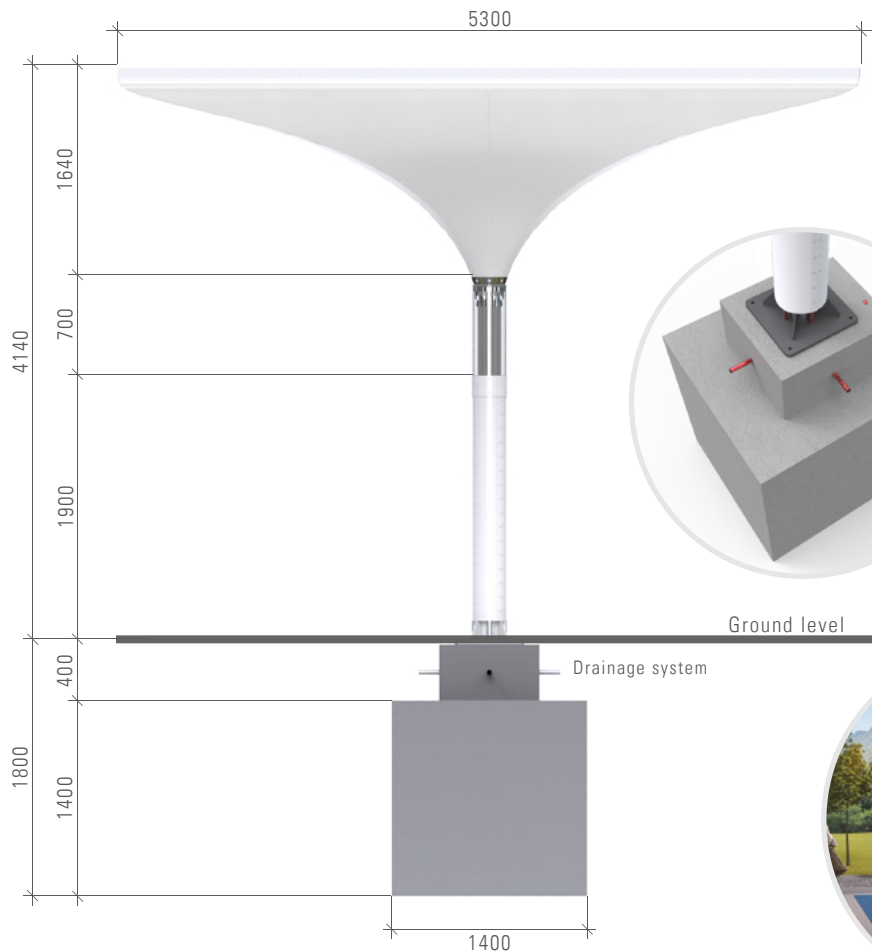

STRUCTURE Fixed, steel construction with central mast and photovoltaic modules above the membrane

Terra HP high power charging
760 X 525 MM, H-1900 MM

DIMENSIONS ARE IN MILLIMETERS
*all measurements are rounded

SMART SOLAR SHELTER

LED ILLUMINATION

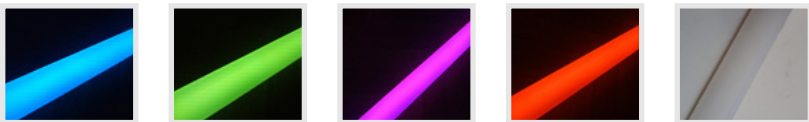
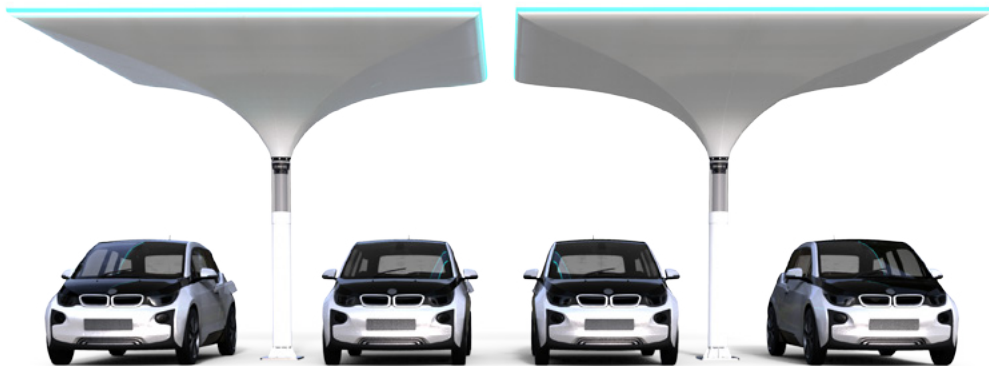
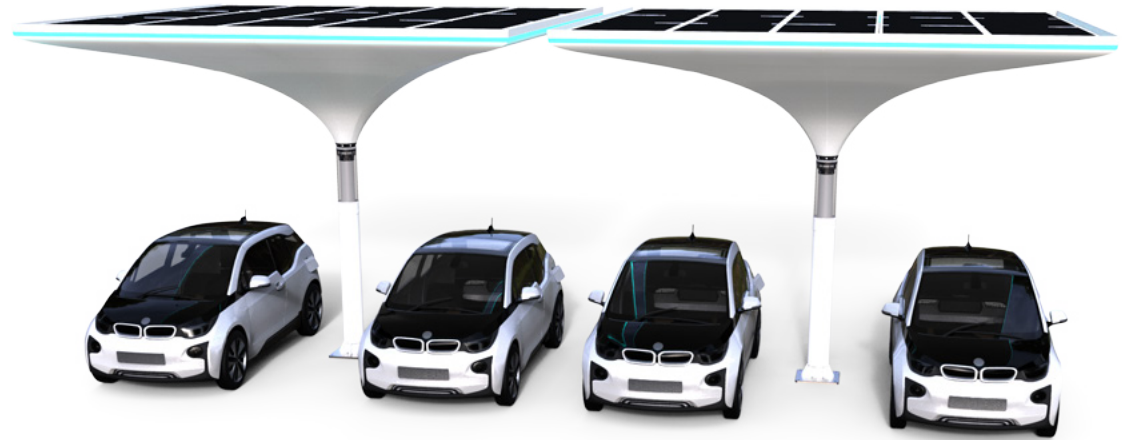

LED OUTDOOR STRIPS 12V, 24W, IP65, 300LEDS/5M REEL, RGB COLORS

SOLAR CHARGING SHELTER

GREEN ENERGY



FRAME

COLOUR

- All RAL colors galvanized/coated
- Ropes & components galvanized
- Steel construction
- Not foldable
- Applicable for snowload up to 75 kg / m²
- Windsafe up to 120 km/h

COVER

MDT-TEX 680

- PVC - coated Polyester weave, min. 620g/m²,
 - Fire protection B1,
 - Flame retardant DIN4102
- more on request

ANCHORINGS

- Footplate welded to the mast
- Anchor on foundation
- Foundation site

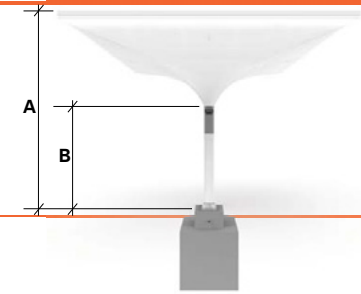

DIMENSIONS ARE IN METERS
*all measurements are rounded

MASS

shelter without packaging (kg)		900
Frame (kg)	Steel construction, painted white, composite mast cladding	520
Cover (kg)	PVC-coated polyester weave, appr. 650 g/s.m	20
PV Panels (kg)		360

HEIGHTS

A Height (cm)	414
B Distance cover to ground (cm)	264

ANCHORING

C Concrete Foundation 140 x 140 x 180cm (l x w x h) with underground drainage

PV SYSTEM

Solar Panels	15 x 270 Wp, Poly-Si, 60 cells, 1640 x 992 x 35 mm	24kg / panel
PV Inverter	SMA Sunny Tripower 5000TL (230 V, 50 Hz, 5000W)	

ENERGY STORAGE

Battery	Li-ion, AXIstorage Li 9s, 8,5 kWh
Battery Inverter	SMA Sunny Island 4.4 M (Rated 230V / AC 172.5V to 264.5V)

HOME ENERGY MANAGEMENT SYSTEM

SMA Sunny Home Manager 2 Ethernet or WLAN via local router, Direct Data Connection (EEBUS, SEMP), Up to 24 devices, 230V / 400V, 50Hz±5%

ILLUMINATION

Integrated LED Lighting in the structure LED Outdoor STRIPS, 12V, 24W, IP65, 300LEDS/5M REEL, RGB COLORS

CHARGERS

22 kW Car Charger Ultra Fast, High Power DC Chargers

RAIN-WATER HARVESTING

D PE Water Storage Tank with German KTW license for drinking water 6.000lt, Ø217cm, 200kg, Long term use temperature max 60°C
WISY® Vortex grin filter, WISY® calmed inlet, WISY® floating suction filter, WISY® multi-functional overflow unit

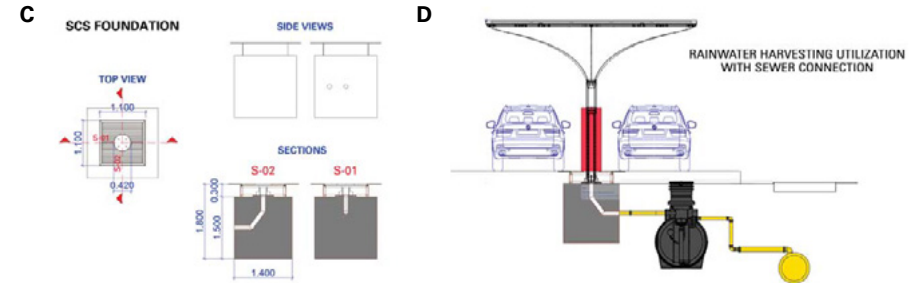

SMART SOLAR SHELTER

WATER HARVESTING



PV PANELS

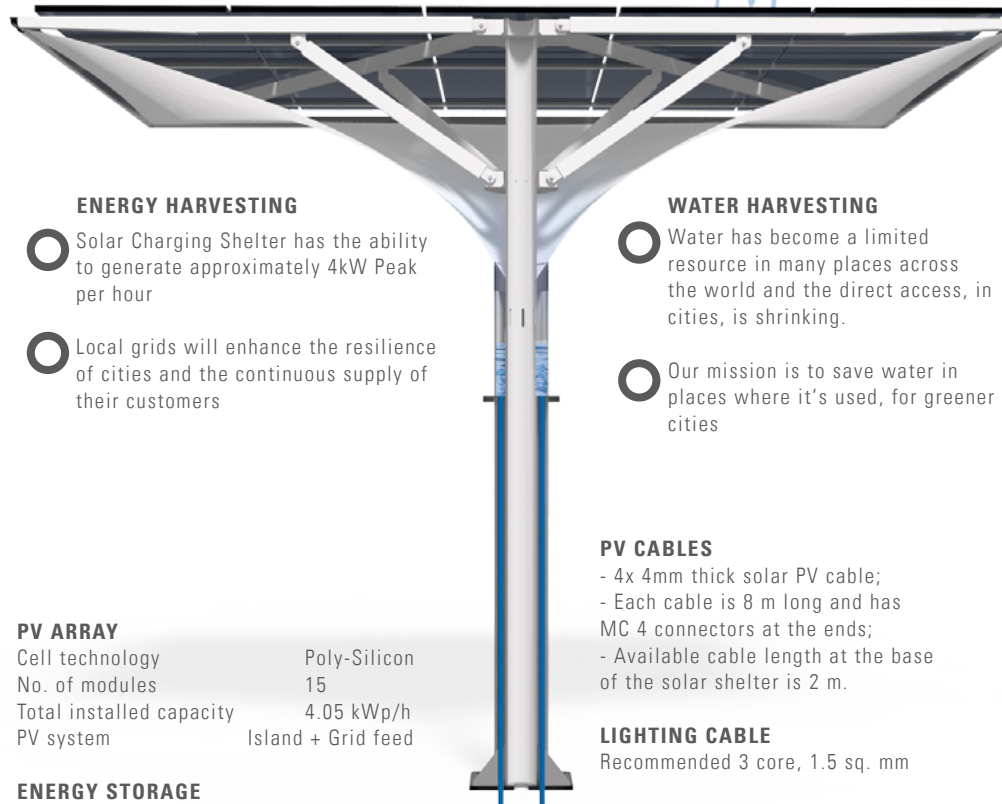

ENERGY HARVESTING

- Solar Charging Shelter has the ability to generate approximately 4kW Peak per hour
- Local grids will enhance the resilience of cities and the continuous supply of their customers

WATER HARVESTING

- Water has become a limited resource in many places across the world and the direct access, in cities, is shrinking.
- Our mission is to save water in places where it's used, for greener cities

PV CABLES

- 4x 4mm thick solar PV cable;
- Each cable is 8 m long and has MC 4 connectors at the ends;
- Available cable length at the base of the solar shelter is 2 m.

LIGHTING CABLE

Recommended 3 core, 1.5 sq. mm

EV CHARGING CABLE

Recommended 5 core, 4 sq. mm cable to support 1 x 22 kW charge

LIGHTNING PROTECTION CABLE

PV ARRAY

Cell technology	Poly-Silicon
No. of modules	15
Total installed capacity	4.05 kWp/h
PV system	Island + Grid feed

ENERGY STORAGE

Total installed capacity	4.5 kWh
Usable capacity	4.05 kWh

CAR CHARGER

Charging rate	22.0 kW
---------------	---------



Reference: **TAGERWILEN, SWITZERLAND 2018**
Type SCP 5.3x5.3 m, Solar Carport

SMART SOLAR SHELTER ENERGY PROVIDER



Reference:

TAGERWILEN, SWITZERLAND 2018

Type SCP 5.3x5.3 m, Solar Carport

SMART SOLAR SHELTER ENERGY PROVIDER



Reference:

TAGERWILEN, SWITZERLAND 2018

Type SCP 5.3x5.3 m, Solar Carport

SMART SOLAR SHELTER ENERGY PROVIDER

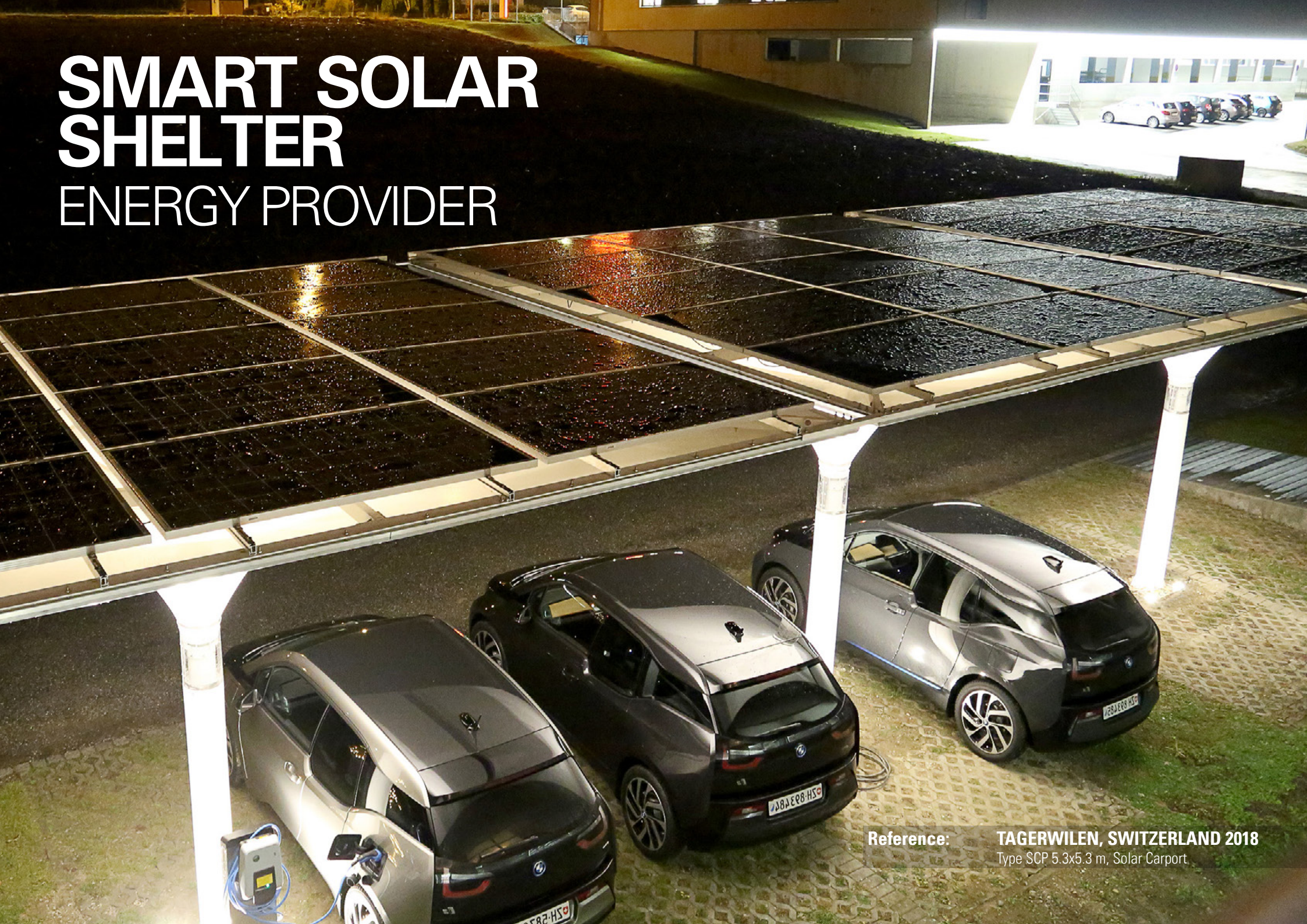

Reference: **TAGERWILEN, SWITZERLAND 2018**
Type SCP 5.3x5.3 m, Solar Carport.

SMART SOLAR SHELTER ENERGY PROVIDER



Reference: **TAGERWILEN, SWITZERLAND 2018**
Type SCP 5.3x5.3 m, Solar Carport

SMART SOLAR SHELTER ENERGY PROVIDER



Reference: **ATLANTA, GA 2018**
Type SCP 5.3x5.3 m, Solar Carport

SMART SOLAR SHELTER ENERGY PROVIDER



Reference: **ATLANTA, GA 2018**
Type SCP 5.3x5.3 m, Solar Carport

SMART SOLAR SHELTER ENERGY PROVIDER

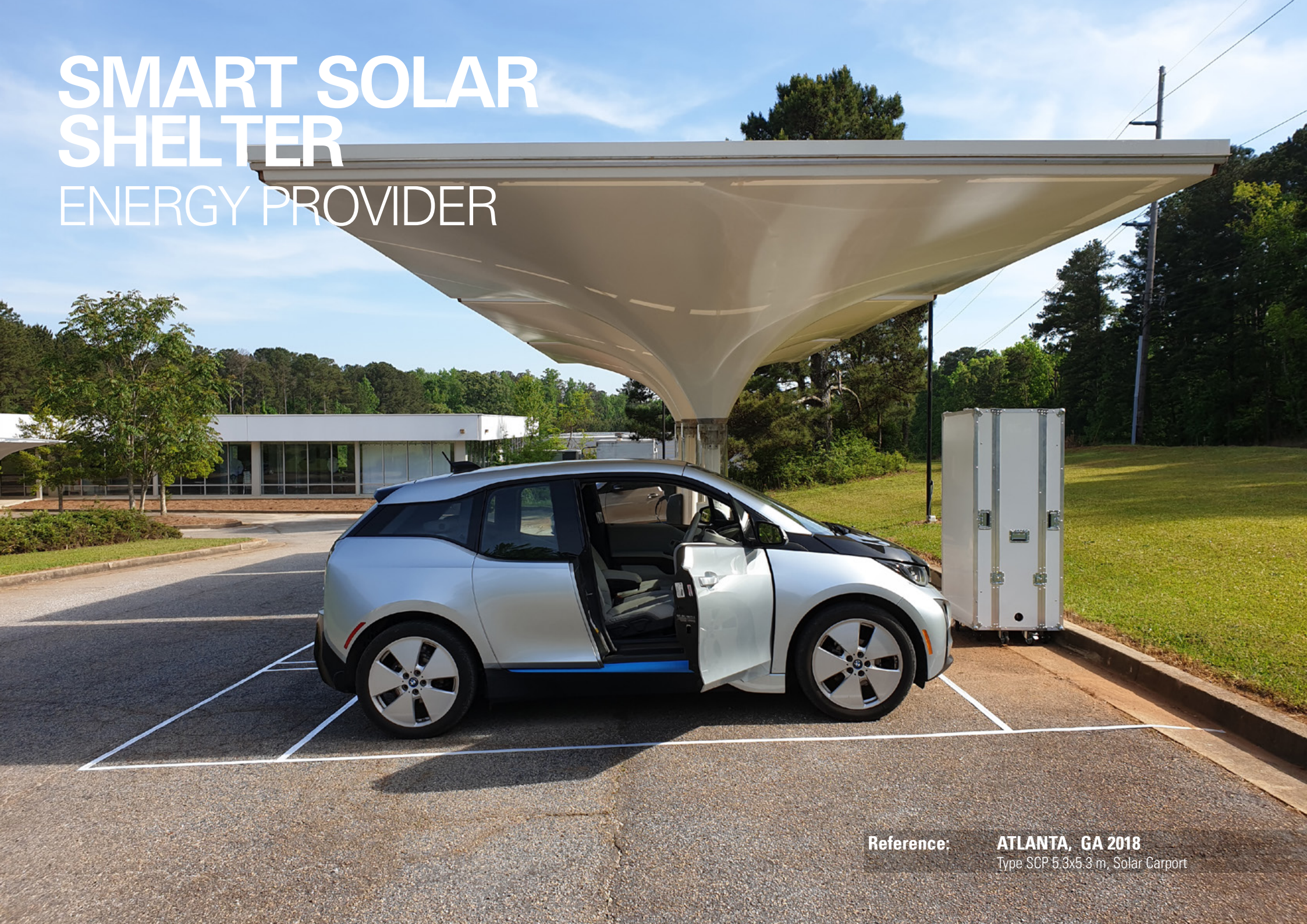

Reference:

ATLANTA, GA 2018

Type SCP 5.3x5.3 m, Solar Carport

SMART SOLAR SHELTER ENERGY PROVIDER

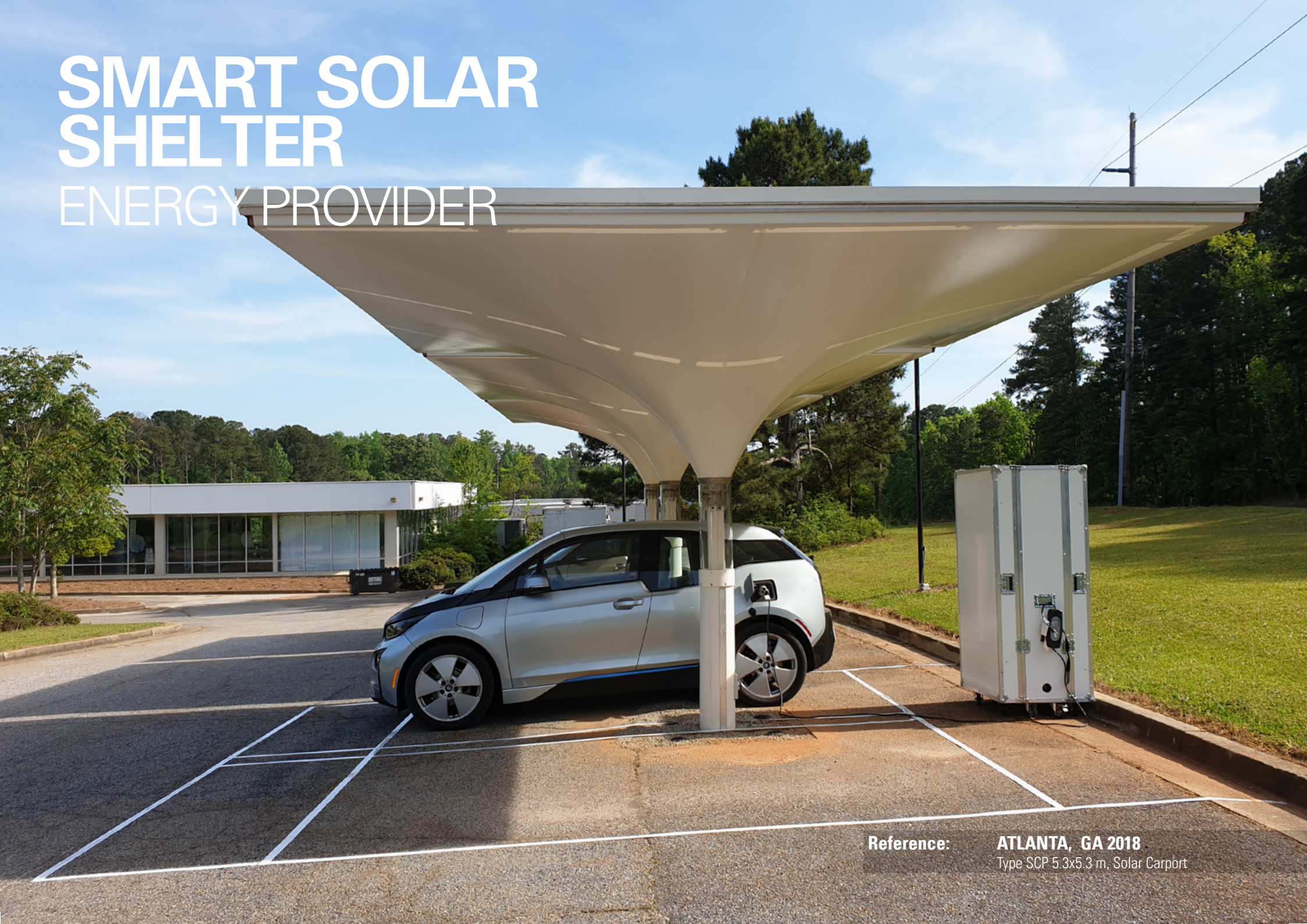

Reference: **ATLANTA, GA 2018**
Type SCP 5.3x5.3 m, Solar Carport

SMART SOLAR SHELTER ENERGY PROVIDER



Reference: **SILVERSANDS, GRENADA 2018**
Type SCP 5.3x5.3 m, Solar Carport

SMART SOLAR SHELTER ENERGY PROVIDER



Reference: **SILVERSANDS, GRENADA 2018**
Type SCP 5.3x5.3 m, Solar Carport

SMART SOLAR SHELTER ENERGY PROVIDER



Reference: **SILVERSANDS, GRENADA 2018**
Type SCP 5.3x5.3 m, Solar Carport

SMART SOLAR SHELTER ENERGY PROVIDER



Reference:

DIELSDORF, SWITZERLAND 2018
Type SCP asymmetric 5.3x5.3 m, Solar Carport

SMART SOLAR SHELTER ENERGY PROVIDER



Reference:

DIELSDORF, SWITZERLAND 2018
Type SCP asymmetric 5.3x5.3 m, Solar Carport

MDT-tex[®]

Membranes & Structures

www.mdt-tex.com

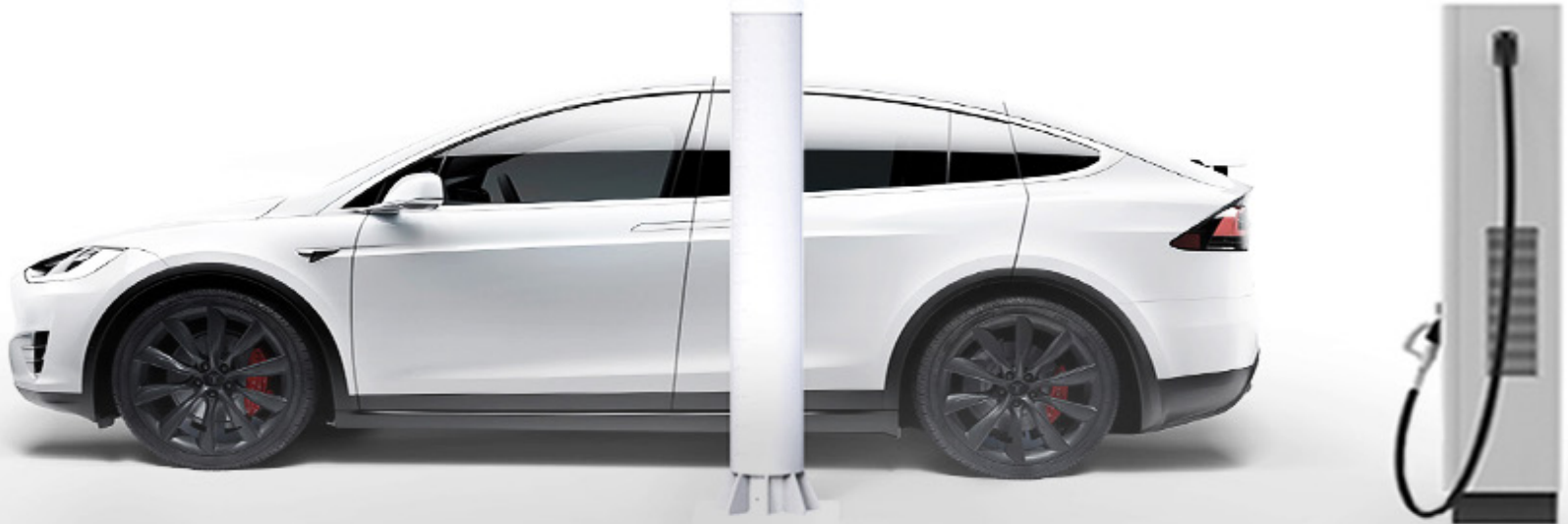

MDT-TEX SHORT FACTS

THE COMPANY

LOCATIONS



MDT's core competence includes in-house R&D as part of the pre-production process. Serially produced items, customised projects and single products are manufactured at different international locations and provide the opportunity to realize customer's wishes promptly and flexibly.

1 GERMANY

HARDHEIM

- Headquarter
- Aluminum, steel and textile production
- Storage
- General & Static engineering
- National & International Sales
- Key Account Management
- Research & Development

3 LATVIA

RIGA

- Aluminum-, textile production & storage
- Product design
- Prototyping / 3d printing
- Powder coating

2 SWITZERLAND

TÄGERWILEN

- Design and Development
- 3d individuell textile formfinding software
- Architecture and innovations
- International Sales
- Key Account Management

4 USA

TYRONE, GA

- International Sales
- Key Account Management
- Supply chain management
- Storage

5 AUSTRALIA

FREMANTLE

- International Sales
- Key Account Management
- Storage